

New Model!



A Green Power® Juice Extractor

COMPLETE GUIDE TO

# GREEN STAR JUICE EXTRACTOR

WITH EXCLUSIVE  
HEAVY DUTY

**TWIN GEAR**

TECHNOLOGY™



## OPERATION MANUAL

- INSTRUCTIONS
- WARRANTY
- OWNERSHIP REGISTRATION
- IMPORTANT SAFETY INSTRUCTIONS
- DO'S AND DON'TS
- WHEN YOU NEED SERVICE
- RECIPES

SAVE THIS MANUAL-KEEP IT HANDY FOR QUICK REFERENCE

---

Congratulations!!!! You are now the proud owner of a new Green Star Juice Extractor. The Green Star Juice Extractor will juice almost anything from carrots and apples to wheat grass and pine needles. You are not limited to just regular juicing but you can enjoy a variety of other delicious foods such as pastas, baby food, breadstick, nut butter, pates, frozen sorbets and more.

The revolutionary design incorporates a twin gear impeller press system that powerfully rotates at a low 110 rpm, that generates virtually no or low heat to your juice. The patented twin gears have magnets and bio-ceramic materials which produces fresher juice that prolongs the storage time of the precious enzymes and vitamins retained in the juice.

After unpacking your Green Star and checking that all the specified parts are there, take time to become familiar with your new Green Star Juice Extractor before you start juicing. It would be a good idea to dismantle and re-assemble the machine a few times to be familiar with how the parts fit together properly. Many parts have been included as standard parts to make your juicing experience easier and to enhance your food preparation versatility.

We recommend washing the parts thoroughly by rinsing the parts in lukewarm water prior to the first usage of the Green Star Juice Extractor. Now you are ready to make your first Green Star juice. Happy juicing to all!!!

# TABLE OF CONTENTS

<b>Warranty</b> .....	4
<b>Warranty Registration Card</b> .....	Insert
<b>When You Need Service</b> .....	5
<b>Important Safety Instructions</b> .....	6
<b>Do' s and Dont' s</b> .....	7
<b>Green Star Juice Extractor Features</b>	
Standard Parts .....	8-9
Parts Order Form .....	10
<b>Assembling and Disassembling</b> .....	11-14
<b>Machine Set-Ups(for different uses)</b>	
Screens and Plastic Plunger .....	15
To juice Wheat Grass .....	15
To make Pasta, Rice Cake(mochi), Bread Sticks, Bagels, etc. ....	16
<b>Cleaning and Maintenance</b> .....	17
<b>Trouble Shooting</b> .....	18
<b>Helpful Hints</b> .....	19
<b>Recipe Index</b> .....	22
Juices and Drinks .....	23~26
Bread Sticks and Mochi(Rice Cakes) .....	27
Pasta and Noodles .....	28
Pate and Croquettes .....	29
Soup .....	30
Dessert .....	31

# WARRANTY (Please read carefully)

---

We warrant to you, the end-user customer who has properly registered after purchasing the Green Star Juice Extractor (hereinafter referred to as "G.S.") for a valuable consideration, that the plastic parts, motor and the Twin Gears of this G.S. will be free from defects in materials and workmanship for a period of five (5) years from the date of purchase. All other parts, including but not limited to the Juice Pitcher, Cleaning Brush, Wooden or Plastic Plunger and the Strainer are not subject to any warranty.

In order for you to receive the benefits of this warranty, you are required to complete and mail the warranty registration card (next 2 pages) to us within ten (10) days following the purchase of your G.S.

1. No warranty will be provided until after we have actually received the enclosed warranty registration card, containing all the requested information, within ten (10) days of the date of the original purchase. The warranty is only good for the original purchaser for value. This warranty is non-transferable.
2. If the G.S. exhibits defects while in normal household use, we, upon our actual receipt of a written notice of such defects from you during the warranty period, we will, at our option, either repair or replace the G.S. which prove to be defective. However, we have no such obligation to repair or replace until after you have, by insured mail and in protective packaging\*, delivered the G.S. to the location of your service center as set forth on page 5. Replacement G.S. may be either new or like-new. G.S. may contain re-manufactured or re-conditioned parts, which are equivalent to new in performance or may have been subject to incidental use.
3. We do not warrant that the operation of the G.S. will be uninterrupted or error free. In no event shall our liability exceed the retail value of the G.S.
4. All warranty and repair services must be performed at a warranty service center, which is located within the country where the Green Star was originally purchased. However, in the event that: [ I ] the machine must be serviced at a service center, which is not located within the country where the machine was purchased; or [ II ] there is no service center within the country where the machine is located and must be shipped to a service center in another country, then those service centers are responsible for the parts and service only, and any and all costs relating to the shipping, delivery and handling of the machine to and from those service centers shall be the sole responsibility of the owner.

This Warranty does not cover defects resulting from: [a] failure to operate the G.S. in accordance with the instructions; [b] use of parts or supplies not provided or authorized by us; [c] negligent, improper or inadequate maintenance; [d] service performed or attempted by unauthorized service person; [e] damages, accidental or otherwise to the G.S., which are not directly caused by us or the manufacturer; or [f] damages resulting from abuse, tampering, misuse, commercial use, or unauthorized modification of the G.S.

WE MAKE NO OTHER EXPRESS OR IMPLIED WARRANTY OR CONDITION WHETHER WRITTEN OR ORAL. TO THE EXTENT ALLOWED BY LOCAL LAW, ANY IMPLIED WARRANTY OF FITNESS FOR A PARTICULAR PURPOSE OR IMPLIED WARRANTY OR CONDITION OF MERCHANTABILITY IS LIMITED TO ONE (1) YEAR. In the event that such limitation or exclusion on the duration of an implied warranty is not allowed in the state or county wherein you reside, the above limitation or exclusion will not apply. This warranty gives you specific legal rights and protection, and you might also have other rights that vary from state to state, or county to county.

TO THE EXTENT ALLOWED BY LOCAL LAW, THE REMEDIES IN THIS WARRANTY STATEMENT ARE YOUR SOLE AND EXCLUSIVE REMEDIES. EXCEPT AS INDICATED ABOVE, IN NO EVENT WILL WE BE LIABLE FOR DIRECT, SPECIAL, INCIDENTAL, CONSEQUENTIAL (INCLUDING LOST PROFIT), OR OTHER DAMAGE, WHETHER BASED IN CONTRACT, TORT, OR OTHERWISE. Some states or counties may not allow the exclusion or limitation of incidental or consequential damages. If you reside in such a state or county, the above limitation or exclusion may not be applicable.

**Do not send your G.S. back to the service center without return authorization.**

**\* Save Original Shipping Box**

---

Place  
Stamp  
Here

---

---

---

## Green Star Juicer Registration:

TRIBEST CORP.  
DBA GREEN POWER INTL  
14109 PONTLAVOY AVENUE, SANTA FE, SPRINGS,  
CA 90670, USA

- Do you have an Internet Service?  
1.  Yes      2.  No
  
- Have you ever purchased any products through Internet Stores?  
1.  Yes      2.  No
  
- Do you use e-mail in your business communication?  
1.  Yes      2.  No      E-mail Address \_\_\_\_\_
  
- Do you use e-mail in your private communication?  
1.  Yes      2.  No      E-mail Address \_\_\_\_\_
  
- Please check all that apply to your household
  1. Regularly Purchase Items  
    Though the Mail
  2. Military Veteran in Household
  3. Member of Frequent Flyer Program
  4. Support Health Charities
  5. Subscribe to Cable TV
  6. Have a Microwave Oven
  7. Have a CD Player
  8. Have a VCR
  9. Use a Personal Computer
  10. Have a Dog
  11. Have a Cat

---

Thanks for taking the time to fill out this questionnaire. Your answers will be used for market research studies and reports and will help us better serve you in the future. They will also allow you to receive important mailings and special offers from a number of fine companies whose products and services relate directly to the information indicated above.

Please check here if, for some reason, you would prefer not to participate in this opportunity. \_\_\_\_\_

If you have comments or suggestions  
about our product, please write to:  
Green Star Customer Relations



# WHEN YOU NEED SERVICE

---

In the unlikely event that you do need service on your GREEN STAR JUICE EXTRACTOR, or if it fails to function properly while within the warranty period (used in normal household operation only.) - PLEASE FOLLOW THE INSTRUCTIONS BELOW :

Contact the nearest authorized Green Star Service Center.

## SERVICE CENTERS

**GREEN POWER INTL.** 14109 PONTLAVOY AVENUE, SANTA FE, SPRINGS, CA 90670, USA

TEL : 888-254-7336, FAX : 562-623-7160

EMAIL : service@greenstarjuicer.com WEBSITE : www.greenstarjuicer.com

- Explain the problem you are experiencing. Call Customer Service(888-254-7336)to get a return authorization number to send your unit to the service center.
- Pack your Green Star securely in the original shipping box. Make sure all parts are enclosed. Fill out the service request form below, detach it and enclose it in the shipping box.
- Securely seal the shipping box with strapping tape.
- Address the box to the service center. Be sure to put your return address on the outside of the package.
- It is always wise to insure the package against possible damages or loss in transit. Ship prepaid.

----- *Detach Form on dotted Line* -----

## SERVICE REQUEST FORM

1. First Name \_\_\_\_\_ Initial \_\_\_\_\_ Last Name \_\_\_\_\_  
Address: Street \_\_\_\_\_ Apt # \_\_\_\_\_  
City \_\_\_\_\_ State \_\_\_\_\_ Zip \_\_\_\_\_  
Phone \_\_\_\_\_
2. Serial# \_\_\_\_\_ Model # \_\_\_\_\_
3. Reason for service request \_\_\_\_\_
4. Date of Purchase \_\_\_\_\_ 5. Place of Purchase \_\_\_\_\_
6. Name of parcel/post carrier (In case of damage during delivery) \_\_\_\_\_

# IMPORTANT SAFETY INSTRUCTIONS

---

1. Please read all instructions carefully.
2. To protect against risk of electric shock, do not put the motor base in water or other liquid.
3. Close supervision is necessary when any appliance is used by or near children.
4. Unplug the appliance from the electrical outlet when not in use, before assembling or disassembling and before cleaning.
5. While the machine is in operation, avoid contact with its moving parts.
6. Do not operate any appliance with a damaged cord or plug, after the appliance malfunctions, is dropped, or is damaged in any manner. Return the appliance to the nearest authorized service center for examination and possible repair to prevent electrical shock or injury.
7. The use of attachments not recommended or sold by the manufacturer may cause fire, electrical shock or injury.
8. Do not use outdoors.
9. Do not let the cord hang over the edge of a table or counter.
10. Do not let the cord contact any hot surfaces such as the stove.
11. Always make sure the two latching arm knobs are fastened securely in place before the motor is turned on. Do not unfasten those knobs while the juicer is in operation.
12. Be sure to turn the switch to the off position after each use. Make sure the motor stops completely before disassembling.
13. Do not put your fingers or other objects into the juicer opening while it is in operation. If food becomes lodged in the feeding chute, use the wooden plunger or another piece of fruit or vegetable to push it down. When this method is not possible, turn the motor off and disassemble the juicer to remove the remnant of food.
14. Your juicer is for household use only.
15. Please refer to : "INSTRUCTIONS" before operating.
16. Please refer to " When You Need Service" in case your juicer is functioning abnormally.
17. Do not disassemble any parts other than those necessary for normal operation or cleaning of your juice extractor (such as housing, twin gears, screen).
18. Your Green Star Juice Extractor must be grounded electrically for proper, safe operation. Use only the 3-prong plug provided. Or use a proper plug or adapter according to the electrical safety code in your country.
19. Do not use the appliance for other than its intended use.

***SAVE THESE INSTRUCTIONS***

---

# DO'S AND DON'TS

## DO :

- Very important! When combining the Twin Gears for assembly- make sure to align the locating dots marked on the surface of the gears.

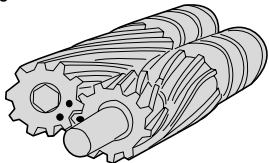

- Soak grains in water for 6 hours or more. Drain the grain and put into the machine a little at a time, together with a small amount of water.

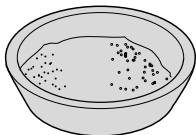

- When you operate your Green Star Juice Extractor continuously, stop operation for 10 minutes after each 30 minutes and then resume operation.

30min / operation  
10min / rest

- Please always put the Feeding Chute into the Twin Gear Housing before using. How to assemble the Feeding Chute can be found on page 11.

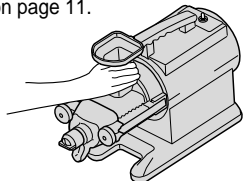

## DON'T :

- Do not lift your Green Star Juice Extractor with wet hands because it is heavy and it may accidentally slip from your grip.

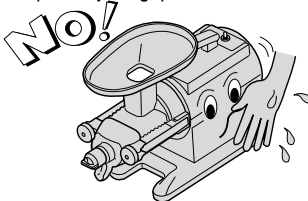

- Do not keep the juice extractor where children can reach it.

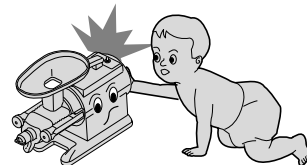

- Do not assemble or disassemble while the power cord is plugged in.

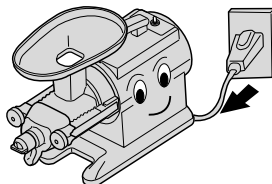

- Do not put any articles such as Knives, spoons, or forks into the Feeding Chute.



- Do not put fingers or hands into the Feeding Chute. Always use the Plunger.

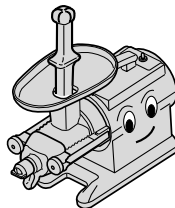

- Do not operate Green Star Juice Extractor on an unstable surface.

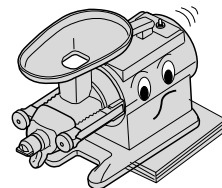

- Do not disconnect the power plug from the electrical outlet with wet hands.

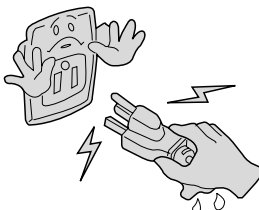

- Do not forcibly operate the juice extractor or overload the Feeding Chute.

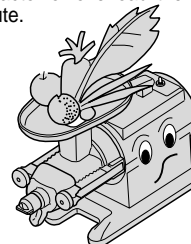





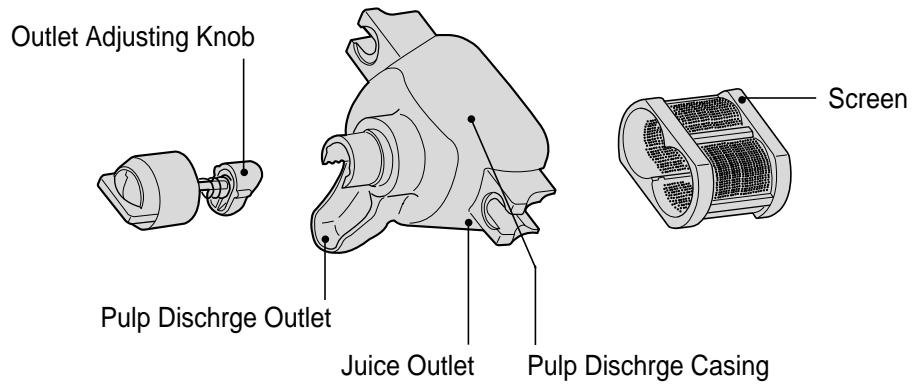



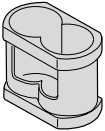
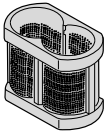



**WARNING : NEVER REMOVE THE TOP SECTION OF THE FEEDING CHUTE WHILE THE JUICER IS IN USE**

# GREEN STAR JUICE EXTRACTOR



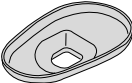



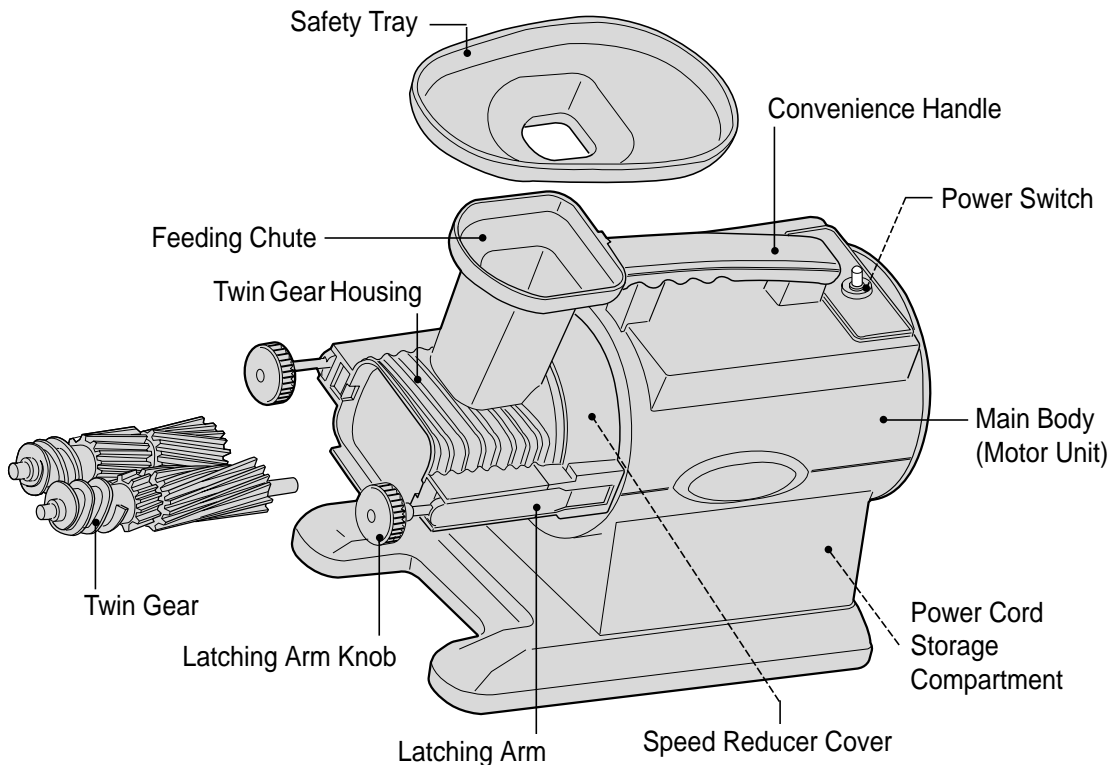

## Green Star Parts(standard for GS-1000):

Homogenizing Blank (Open Blank) CJST1-051A 	Fine Screen CJST1-034A 	Juice Pitcher CJST1-040A 	Cleaning Brush CJST1-039A 	Plastic Plunger CJGP5-036A 	Wooden Plunger CJST1-038A 	Drive Gear CJST1-044A 	Free Wheel Gear CJST1-045A 
Twin Gear Housing CJGS5-024A 	Pulp Discharge Casing CJGS5-028A 	Outlet Adjusting Knob CJGS5-026A 	Latching Arm Knob CJGP5-006A 	Safety Tray CJGP5-037A 	Feeding Chute CJGP5-027A 	Feeding Chute Cover CJGP5-029A 	

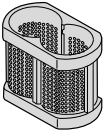
# FEATURES AND PARTS

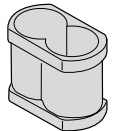

## Green Star parts(optional parts available for upgrade):

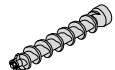
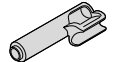
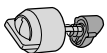
Coarse Screen CJST1-035A 	Strainer CJST1-042A 	Bread Stick Blank (Closed Blank) CJST1-033A 	Bread Stick Guide CJGS5-042A 	Drip Tray CJGP5-038A 	Pasta Screen CJST1-032A 	Pasta Screw CJST1-030A 	Pasta Guide CJST1-031A 
Outlet Adjusting Knob-Soft CJGS5-027A 							

# GREEN STAR PARTS:

## GREEN STAR PARTS & Order Form

NO. Ordered	Part Number	GS-1000	GS-2000	GS-3000	Unit Price	Quantity	Total		
	Main Body With Motor	included	included	included	\$195.00				
	Twin Gear Housing	CJGS5-024A	included	included	included	\$35.00			
	Pulp Discharge Casing	CJGS5-028A	included	included	included	\$20.00			
	Outlet Adjusting Knob-Regular	CJGS5-026A	included	included	included	\$10.00			
	Drive Gear	CJST1-044A	included	included	included	\$50.00			
	Free Wheel Gear	CJST1-045A	included	included	included	\$50.00			
	Fine Screen	CJST1-034A	included	included	included	\$22.00			
	Homogenizing Blank	CJST1-051A	included	included	included	\$9.00			
	Juice Pitcher	CJST1-040A	included	included	included	\$12.00			
	Wooden Plunger	CJST1-038A	included	included	included	\$6.00			
	Plastic Plunger	CJGP5-036A	included	included	included	\$9.00			
	Cleaning Brush	CJST1-039A	included	included	included	\$6.00			
	Safety Tray	CJGP5-037A	included	included	included	\$9.00			
	Coarse Screen	CJST1-035A	Optional	included	included	\$22.00			
	Strainer	CJST1-042A	Optional	included	included	\$8.50			
	Drip Tray	CJGP5-038A	Optional	included	included	\$9.00			
	Bread Stick Blank	CJST1-033A	Optional	Optional	included	\$9.00			
	Bread Stick Guide	CJGS5-042A	Optional	Optional	included	\$9.00			
	Pasta Screen	CJST1-032A	Optional	Optional	included	\$25.00			
	Pasta Screw	CJST1-030A	Optional	Optional	included	\$9.00			
	Pasta Guide	CJST1-031A	Optional	Optional	included	\$9.00			
	Outlet Adjusting Knob-Soft	CJGS5-027A	Optional	Optional	Optional	\$10.00			
Assorted Sets price									
	Twin Gear Set	Includes 1 Free Wheel Gear & 1 Drive Gear			\$95.00				
	Pasta Set	Includes 1 Pasta Screen, 1 Pasta Screw & 1 Pasta			\$43.00				
	Bread Stick Maker Set	Includes 1 Bread Stick Blank & Bread Stick Guide			\$18.00				
<b>Shipping &amp; Handling Chart</b> <small>(Via Surface)</small> Merchandise Subtotal Less than US\$20.00 US\$20.00 - US\$30.00 Over US\$30.00				Subtotal					
				Shipping & Handling charge		TAX			
				US\$7.00		Shipping/Handling			
				US\$8.00		Total Enclosed			
				US\$8.00 plus 5% of Subtotal					

### Payment Method

\_\_\_\_\_ Check/Money order payable to Tribest Corp. enclosed.

\_\_\_\_\_ Visa or \_\_\_\_\_ Master card shown below

Card Number

□□□□ □□□□ □□□□ □□□□

Card Holder's Name

Authorized Signature

Expire

□□ □□

Date

Your Business Name :

Billing Address :

Shipping Address : (if different from billing)

Phone Number :

Buyer and Signaure :

# GREEN STAR ASSEMBLY

Safety Reminder: Make sure to unplug from the outlet before assembling.



1. Join the **Twin Gear Housing** to the body with the Latching Arm Knobs loosened and the Latching Arms open.

Insert the Feeding Chute into the Twin Gear Housing “neck”, with the small rectangular tab toward the rear of the machine.

**Note :** Before putting your machine away for future use, once it has been cleaned and dried, cover the Feeding Chute with its protective lid. Simply place the Feeding Chute Lid on top of the Feeding Chute, with the two “ears” pointing to the sides of the juicer and the oval end of the lid toward the front of the machine. Gently push it down into position. Remove lid before using the juicer.



Drive Gear Free Gear



Position the 1 dot between the 2 dots and insert them in to the twin gear housing.

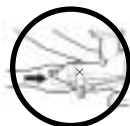

## 2. Very Important!

Assemble the **Twin Gears** as follows: Find the ‘**Locating Dots**’ marked on the end surface of each gear. Position the ‘**Locating Dots**’ so that the single dot is between the two dots on the other gear. Holding the Twin Gears in this position, insert them into the **Twin Gear Housing**.

While assembling your juicer, if you want to check whether the Twin Gears are seated properly, look down the feeding chute. If you see any part of the drive shaft in front of the left hand side gear, you need to jiggle/push the left hand side gear a little more. If all you see is the gear threads, the gears are fully seated into position.

Failure to properly seat the Twin Gears could result in damage to the Gears and the Drive Shaft which may not be covered under the warranty.

## GREEN STAR ASSEMBLY (Cont'd)

---



3. Slide the desired **Screen** or **Blank** over the **Twin Gears** and into the **Twin Gear Housing**.



4. Slide the **Pulp Discharge Casing** over the **Twin Gear Housing**.



5. Place each **Latching Arm** into the corresponding groove of the **Twin Gear Housing**. Turn both **Latching Arm Knobs** clockwise and tighten.



6. Assemble the **Outlet Adjusting Knob**. When the **Outlet Adjusting Knob** comes to a stop, it is considered 'tight'. You may be able to twist the knob to get it to go in further, but, do not over-tighten.



7. Place the **Safety Tray** on the **Feeding Chute**.

# GREEN STAR DISASSEMBLY

---

Safety Reminder: Make sure to unplug from the outlet before disassembly



1. Remove the **Safety Tray** by lifting it vertically from the **Feeding Chute**.



2. Turn the **Outlet Adjusting Knob** counter clockwise until it separates from its threads; then pull it out from its grooves.



3. Turn the **Latching Arm Knobs** counter clockwise to loosen. Open the **Latching Arms** horizontally outward on their hinges.



4. Remove the **Pulp Discharge Casing**.

## GREEN STAR DISASSEMBLY (Cont'd)

---



5. Remove the **Screen**. The Twin Gears may come out with it. Be careful not to drop the **Twin Gears**.



6. Slide the **Twin Gears** out.



7. Remove the **Twin Gear Housing** by grasping the **Feeding Chute**. Then, gently pull it away from the body of the machine.

---

Note : The **Twin Gears** on your juicer never need sharpening. They are not blades. They work by “biting” off small bits of produce at a time – much like your teeth. They do not cut, chip or tear the produce that builds up heat which destroys enzymes.

---

# MACHINE SETUP

## Screens ----- Which one to use



1. **Fine Screen** separates maximum pulp from the juice. However, the pressure built up inside of the screen could push some finely ground pulp through holes of the screen. So, minimum pulp may be contained in the juice. Use to juice: carrot, parsley, kale, angelica utilis, wheatgrass, other green leafy vegetables and herbs.



2. **Coarse Screen** ; allows some pulp to mix with the juice. Use to juice: Apples, Oranges, many other kinds of fruits and vegetables.(This part is optional for GS-1000)

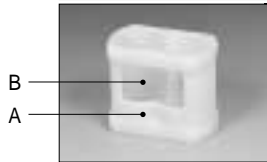

3. **Homogenizing Blank (Open Blank)** ; to puree, frozen desserts, baby foods, nut butters, apple sauce, pate, relish, etc. use with: grains, garlic, banana, strawberry, nuts, etc. To use the Homogenizing Blank, insert side "A" first with hole "B" facing downwards, over the Twin Gears and into the Twin Gear Housing.

## How to use Plastic Plunger

When you use the Plastic Plunger, please place the Safety Tray on top of the Feeding Chute, pointing the marked arrow(←)toward the **Outlet Adjusting Knob**.

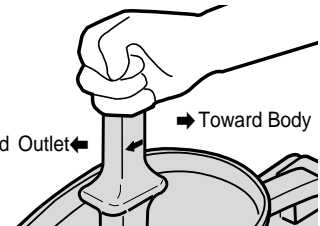

## How to use Drip Tray

Position the bigger end of the Drip Tray underneath the front two legs of the juicer under where the juice drips. Set the juice pitcher on top for collecting juice.

## Using the Wooden Plunger?

Do not be timid about touching the **Twin Gears** with the wooden plunger while juicing. It will not harm either the gears or the plunger. The plunger is made from the same high quality wood as many fine chopping blocks, so any accidental particles of cellulose scraped off by contact with the **Twin Gears** are non-toxic and will pass through harmlessly with the pulp.

## To juice wheat grass (Also barley grass, alfalfa & others)

1. Fit the juice extractor with the **Fine Screen** for maximum juice extraction and pulp separation.
2. Close the **Outlet Adjusting Knob** completely.
3. With the power switch in the "on" position; place a bunch of wheat grass (approx. 3/4 inch in diameter) tip down, into the **Feeding Chute**.

## MACHINE SETUP (Cont'd)

4. After a few drops of juice come out from the **Pulp Discharge Outlet**, loosen the **Outlet Adjusting Knob** about half way.
5. Carrots, apples and other “more palatable” fruits and vegetables can be added to create a milder tasting combination for those who have not yet “acquired” a taste for pure wheat grass juice.

**Note:** Please refer to “Wheat Grass Delight” on page 22.

### To make pasta

1. Attach the **Twin Gear Housing** to the juicer body.
2. Take out the **Twin Gear** and insert the **Pasta Screw** onto the motor drive shaft (left side as you are looking at the front of the body).
3. Put the **Pasta Guide** over the **Pasta Screw**, making sure the long side of the **Pasta Guide** faces to the left side.
4. Select the pasta type which is desired from the two shapes provided on the **Pasta Screen** and fit it onto the **Pasta Guide**.
5. Tighten the **Latching Arm Knobs**.
6. The machine is now ready to make pasta.
7. Be sure the dough is not too moist.

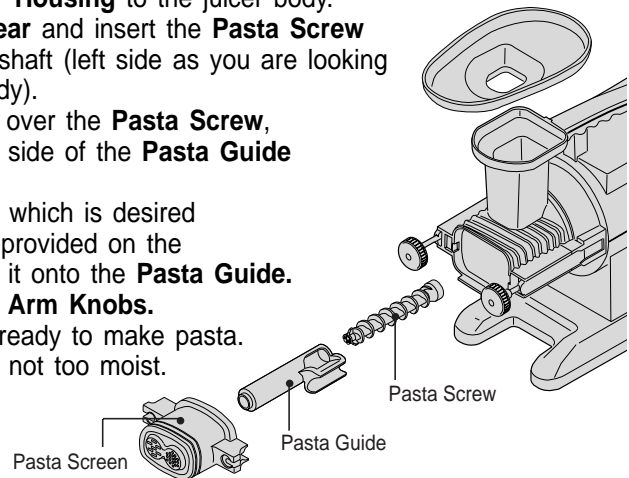

### To make bread sticks, bagels, rice cake (mochi), etc.

1. Replace the juicing screen with the **Bread Stick Blank**.
2. Attach the **Pulp Discharge Casing** to the **Twin Gear Housing**, thus locking the **Bread Stick Blank** into position.
3. Unscrew the **Outlet Adjusting Knob** (not shown here) from the **Pulp Discharge Casing** and replace it with the **Bread Stick Guide**.
4. Place the **Safety Tray** into position.
5. Add materials to be used into the **Feeding Chute**.

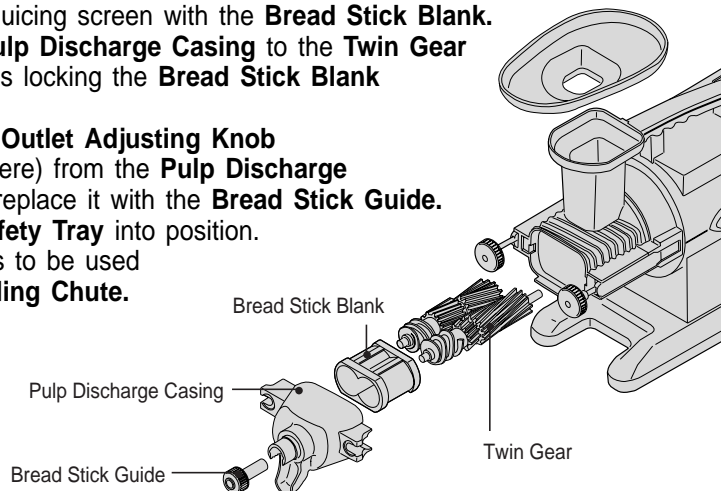

# CLEANING AND MAINTENANCE

---

## Proper Cleaning Lengthens the Life Span of the Juice Extractor

- Since Green Star extracts minerals, such as calcium, from the produce so well, we recommend cleaning all of the juicer parts immediately after use to prevent mineral build-up which can cause problems.
- Completely disassemble the **Pulp Discharge Casing** and **Twin Gear Housing** sections. Immerse them in water and clean them with the **Cleaning Brush**, which is provided for your convenience.
- After cleaning the juice extractor, let it dry thoroughly.

---

## To Remove Calcium and Mineral Deposits from the Twin Gears

- After using the machine for some time, you may notice a calcium or mineral deposit on the surfaces of the **Twin Gear** unit. This deposit needs to be removed as follows: After juicing carrots, feed some of the carrot pulp back through the machine and then add some granulated sugar(Ratio : one table-spoon of carrot pulp to one or two tea-spoon of granulated sugar). Alternate pulp and sugar several times and then run the machine.

---

## Cleaning Procedure

- First - make sure the machine is switched off and, for added safety, remove the plug from the wall and store it in the **Cord Storage Compartment**.
- Because your **Green Star Juicer** extracts calcium and other substances from the produce as it goes through the machine, it is essential to wash up immediately after use, otherwise the calcium may cake up on various parts and may cause problems.
- Disassemble the juicer as shown on page 13-14 and immerse each component in lukewarm water. Clean out all the pulp with the multipurpose **Cleaning Brush** provided, using the thinner end to force out the pulp, which normally collects in the **Pulp Discharge Outlet**.
- When using the **Fine Screen**, brush away from the corners, avoiding a build-up of pulp, which will be difficult to remove later.
- Under no circumstances should you allow water to enter the main body of the machine. Please refer to HELPFUL HINTS(page 20).
- Rinse the soapy water from the components, dry them thoroughly before they are reassembled.
- You will find it difficult to prevent some of the inside surfaces from becoming stained by harmless pigments contained in certain fruits and vegetables, but the outside surfaces should always remain stain free.
- Do not use harsh chemicals, such as bleach to remove food stains from the juicer.
- Do not drop any of the components, particularly the **Twin Gears** which are very expensive. Our warranty does not cover accidental damage.
- Do not put any parts into the dishwasher.  
(The plastic part are not dishwasher safe).

# TROUBLE SHOOTING

Symptom - What if:	Check to see if:
Machine doesn't turn on.	<ul style="list-style-type: none"> <li>The power supply is active; the plug is correctly positioned in the electrical outlet and the machine is switched on.</li> <li>The fuse is okay.</li> </ul>
Machine stops	<ul style="list-style-type: none"> <li>The machine is correctly assembled.</li> <li>The machine is overloaded? If so, it will stop automatically.</li> <li>The material you are trying to process is cut too large or is too hard.</li> <li>The fuse is okay.</li> </ul>
Noisy gears	<ul style="list-style-type: none"> <li>The Twin Gears are correctly aligned.</li> <li>There is any hard material lodged in the gears.</li> </ul>
Pulp discharge casing doesn't fit properly	<ul style="list-style-type: none"> <li>Left-hand side Twin Gear is not seated correctly - give it a twist while pushing in gently to seat it securely.</li> </ul>
Pulp discharge casing begins shaking	<ul style="list-style-type: none"> <li>The Latching Arm Knobs are securely tightened</li> </ul>
Pulp is not being ejected	<ul style="list-style-type: none"> <li>Loosen the Outlet Adjusting Knob</li> </ul>
Too much pulp	<ul style="list-style-type: none"> <li>Tighten the Outlet Adjusting Knob</li> </ul>
Pulp comes out with juice	<ul style="list-style-type: none"> <li>The Screen is in position</li> <li>Tighten the Outlet Adjusting Knob</li> </ul>
Low amount of juice	<ul style="list-style-type: none"> <li>Outlet Adjusting Knob is in position, or needs to be tightened.</li> </ul>
Material jammed	<ul style="list-style-type: none"> <li>Flick the power switch to the reverse position once or twice.</li> <li>If it doesn't clear, machine must be dismantled to clear the blockage.</li> </ul>

## Fuse Location and How to Change the Fuse

- Unplug the juicer from the wall socket and store the cord in the Cord Storage Compartment.
- Locate the square plate on the bottom of the GS Juice Extractor. Using a small screwdriver (Phillip's head), remove the two screws that hold the plate in position. Remove the square plate.
- Find the round, capsule-shaped, milky-colored fuse casing inside of the machine. There is a white wire extending from each end of the capsule.
- Grasp one end of the fuse casing between the index finger and thumb of one hand; and the other end of the fuse casing in the other hand. Push both ends toward the center and twist to open the fuse holder. Release both ends.
- Remove the old fuse from the casing and discard properly. Place a new fuse into the casing. Close the fuse casing by reversing the procedure in Step 4, above.
- Replace the square bottom plate and the two screws to secure to plate.



If your Green Star Juice Extractor still experiences a problem after using the suggestions given in the Trouble Shooting Section, please contact your nearest authorized service center.

Green Star requires special repair procedures; therefore repairs beyond the scope of the Trouble Shooting Chart should never be attempted by anyone other than an authorized service center.

Once the machine has stopped, please wait and try to turn it on again approximately 10 minutes later.

In the unlikely event that the Feeding Chute becomes clogged or jammed while juicing or processing any food item:

- Switch the on / off lever to the reverse position to dislodge the food.
- If A, above, did not dislodge the food **TURN THE MACHINE OFF AND DISCONNECT IT FROM THE ELECTRICAL OUTLET (FOR SAFETY)**. It is now safe to use a suitable, blunt tool to loosen whatever food is lodged in the Feeding Chute.

## HELPFUL HINTS

---

### NOISES

Even though the Green Star juicer is very quiet, there may be some normal noises. Please test your juicer as follows ;

1. Completely disassemble your Green Star and then turn on the motor. You will hear a normal humming motor sound. If you hear any squeaking sound, your juicer may need lubrication between the Drive Shaft and the rubber seals. Do not be intimidated because of this noise. It is a very minor problem and does not affect the juicer's performance nor will it damage any other parts on your juicer. Please call your service center for instructions on how to lubricate your juicer.
2. Fully assemble your juicer and turn it on without adding any produce. You will hear the Twin Gear sound. You may hear a thumping sound which is normal. The Twin Gears may have minor variations and the thumping sound is considered acceptable. This minor variation will not affect the function nor will it damage any parts.
3. While you are juicing you may hear a squeaking or chirping sound – that noise is also considered to be normal.

### MOVEMENTS

Because of the pressure build up around the screen while you are juicing, the front part of the Green Star may wiggle. The flexing is normal and will not cause damage to any part involved because all the front parts are rubber cushioned.

### JUICING

Remember that your juicer needs time – it is only revolving at 110 rpm. The most nutritious juice is made slowly, allowing the produce to come into contact with the magnetic field (focused only in the tiny space between the gears) for a maximum length of time. Also, slow juicing is more gentle, creating less heat build up.

#### 1. Carrot

The Twin Gears are not blades – you will need to firmly push carrots into slowly rotating gears. Cut thicker carrots into lengthwise pieces for easier juicing. The Plastic Plunger does not reach all the way to the gears – so try tapping that last bit of carrot with the Wooden Plunger for complete juicing.

#### 2. Wheat Grass

To minimize the amount of foam produced... refrigerate the gears and wheat grass about 2 hours or even overnight before juicing. As you are juicing spray some water on wheat grass.

Another way to reduce the amount of foam produced is to pour a 1/2 teaspoonful of flaxseed oil (a good source of omega-3's) into the feeding chute while the machine is running, before juicing your wheat grass. If less oil is desired, you may brush it lightly onto the Twin Gears before assembly.

If you do not mind wheat grass juice mixed with carrot juice, you will get maximum yield on the wheat grass juice with minimum foam by alternating wheat grass and carrot while juicing.

#### 3. Leafy Vegetables

To juice leafy vegetables easily, simply roll the leaf into a cylindrical shape and insert into the Feeding Chute.

## CLEAN UP

Maintaining maximum cleanliness of your juicer is extremely important for both your health and the peak performance of the machine. We recommend cleaning the juicer immediately after each use, since cleaning the machine as quickly as possible is the easiest way to remove food particles. However, if you want to juice throughout the day without disassembling the machine, totally remove the Outlet Adjusting Knob, place a large bowl under both the Juice Outlet and the Pulp Discharge Outlet, turn on the machine and pour about 16 ounces of water through the machine.

### 1. Stains and Mineral Deposits

Colored stains and mineral deposits on parts are normal usage signs of a product. But to remove color stains and mineral deposits.

#### 1) Stains

- Do not use harsh chemicals such as bleach to remove food stains from the juicer.
- You can use a 25%-50% white vinegar/water solution and soak the parts overnight. This may be repeated if necessary.
- Juicing green honeydew or cantaloupe melons may also lighten the stains.
- Stains from juicing carrots may be removed by gently rubbing the stains with olive oil or canola cooking oil and a paper towel.

#### 2) Mineral Deposits

- Using Baking soda  
4 tablespoon of baking Soda  
2 cups(16 oz) of lukewarm water

Soak the parts in the solution of water and baking soda overnight to loosen the mineral deposit and to remove the colored stains. Wash with soap and water and use a hard bristled brush to remove mineral deposit. Wipe with cloth to dry.

- Mineral Deposits may be removed from the tips of the Twin Gears by running soaked almonds through the machine.
- Another excellent way to remove mineral scales is to soak those affected parts in a pure vinegar bath overnight. This loosens the scaling and much of it can be brushed off. This process may be repeated as necessary. The vinegar used for de-scaling can be stored for reuse. Please label the storage bottle properly so that it is not accidentally used in food preparation.

### 2. The Screen

- Hold the screen under running water while brushing the pulp residue from inside the screen first, and then the outside of the screen.
- For pulp that has been imbedded firmly in the holes of the screen, try soaking the screen for a couple of hours in water after brushing away as much pulp as possible.
- You may also try using the DULL side of a table knife to rub along the inner surface of the screen and then brushing from the outside with the Cleaning Brush.

### 3. The Main Body(Motor Unit)

To clean the motor unit of your juicer, position the front two legs over the edge of the sink. With either the sink top sprayer, a spray bottle filled with water, or an empty detergent bottle filled with water and equipped with its squirt-top, spray water directly onto the front plate of the juicer where the drive shaft, mounting peg and free wheel gear seats to remove pulp residue. Wipe any other exterior surfaces with a damp

---

cloth. DO NOT SUBMERGE THE MOTOR UNIT INTO WATER AT ANY TIME.

**4. Others**

- Use the narrow, pointed end of the cleaning brush to push food through out through the pulp discharge outlet.
- Dried fruits and nuts can be very sticky on the inside surfaces of the juicer. To remove the residue more easily run a couple of stalks of celery through before disassembling the machine.
- To help the Twin Gears retain their shine, alternate between running one tablespoon of carrot pulp and one teaspoon of granulated white sugar through the machine several times.

# RECIPE INDEX

## JUICE AND DRINKS

Citrus Blend -----	23
Apple Lemonade -----	23
Wheat Grass Delight -----	23
Ambrosia Nectar -----	24
Watermelon Quench -----	24
Mellow Melon Punch -----	25
Snappy Apple -----	25
Dr. Wallker's Choice(#61) -----	25
Green Tang -----	26
Oriental Express -----	26

<b>RYE BREAD STICKS AND MOCHI(RICE CAKE) -----</b>	<b>27</b>
--	-----------

<b>PASTA AND NOODLES -----</b>	<b>28</b>
--------------------------------	-----------

## PATE AND CROQUETTE

Cashew, Curry Croquettes -----	29
Pecan Pleasers -----	29

## SOUP

Beef Borscht -----	30
--------------------	----

## DESSERTS

Cashew Poppy -----	31
Banana-Blueberry Ice Cream Pie (uncooked) -----	31

# JUICES AND DRINKS

---

## MACHINE SET-UP FOR ALL JUICES AND DRINK RECIPES:

1. Place the **Twin Gears** in position
2. Use the **Fine Screen**
3. Tighten the **Latching Arm Knobs** snugly.
4. The **Outlet Adjusting Knob** closed.
5. Put glass Juice Pitcher under the **Juice Outlet**.
6. Put container under the **Pulp Discharge Outlet** to catch residue.

**Notice:** When juicing a combination of hard, fibrous vegetables such as carrots or beets and leafy greens, such as herbs or grasses PLEASE BE SURE to completely empty the Feeding Chute of all fibrous vegetables before introducing any of the leafy greens.

### Citrus Blend

- 2 SMALL GRAPEFRUIT (Peeled and cut into 4 to 6 pieces)
- 3 MEDIUM SIZE ORANGES (Peeled and cut into 4 pieces)
- ½ SMALL LEMON (Peeled and cut into 2 pieces)
- ½ SMALL LIME (Peeled and cut into 2 pieces)

**Note :** 1) For sweeter taste - use less lemon and lime  
2) It is not necessary to peel the lemon or lime.

### Apple Lemonade

- 3 FIRM APPLES (YELLOW DELICIOUS, PIPPIN, OR GRANNY SMITH, Cut into 6 pieces)
- 3 MEDIUM SIZE ORANGES (Peeled and cut into 4 pieces)
- ½ LEMON (Peel is optional for sweeter flavor)

### Wheat Grass Delight

- 4 HANDFULS WHEAT GRASS
- 4 CARROTS (Cut in 2 to 4 pieces)
- 1 FIRM APPLE (Cut into 6 pieces)
- THIN SLICE GINGER

### Ambrosia Nectar

2	BUNCHES	GRAPES
3		APPLES (YELLOW DELICIOUS, GRANNY SMITH, OR PIPPIN - Cut into 6 pieces)
1		KIWI (Peeled and cut into 2 pieces)
1	SLICE	HONEYDEW (Cut into cubes)
1	SLICE	PINEAPPLE (Cut into cubes)
1	WHOLE	LEMON (Peeled and cut into 4 pieces)
½	CUP	CRANBERRIES

#### Method:

1. Alternate juicing grapes, kiwi pieces, melon cubes, pineapple cubes, apple pieces and cranberries
2. Juice lemon separately and add to taste

*Note: Quantities of ingredients may be varied with good results  
Do not be afraid to experiment according to your own taste*

### Watermelon Quench

1. Watermelon with seeds - If organically grown, add rind also

#### Method:

1. Slice watermelon into pieces that fit easily into the feeding chute of the juicer.
2. Juice & enjoy on a hot summer day

### Mellow Melon Punch

¼		CANTALOUPE (cut into cubes)
¼		HONEY DEW (cut into cubes)
2"	SLICES	WATERMELON (cut into cubes)

Juice all together and enjoy

### Snappy Apple

7		APPLES (FUJI, GRANNY SMITH, YELLOW DELICIOUS - Cut into 4 to 6 pieces)
½		JALEPENO PEPPER
¼		LIME
1		KIWI (Peeled and cut into 2 pieces)

Method:

1. Juice Kiwi and Lime first
2. Next juice Jalepeno
3. Finish by juicing the Apples

### Dr. Walker's Choice (#61)

10 oz.		CARROTS (Cut into 4 pieces)
6 oz.		SPINACH (FRESH)

Method:

1. Juice spinach first
2. Juice carrots

### Green Tang

2		PINEAPPLE WEDGES (Cut into smaller pieces)
1	SPRIG	MINT
3	HANDFULS	WHEAT GRASS
¼		LEMON
1	SLICE	GINGER FOR FLAVOR

#### Method:

1. Juice wheat grass
2. Juice the mint
3. Juice lemon
4. Juice pineapple cubes

**Note:** Pineapple wedge is a 1" round slice of whole pineapple cut into quarters (4 pieces). If pineapple is not organically grown, remove the outer skin before juicing

### Oriental Express

3	LEAVES	NAPA CABBAGE - Cut lengthwise
4	STALKS	BOK CHOY WITH LEAVES - Cut lengthwise
2	STALKS	ANISE (FENNEL) with GREEN STEM and LEAVES
6		MEDIUM CARROTS (Cut into 4 pieces)
2		APPLES (YELLOW DELICIOUS, FUJI, OR GRANNY) - Cut into 4 to 6 pieces

#### Method:

1. Juice Napa, Bok Choy and fennel first
2. Juice Apples second
3. Juice Carrots into the rest of the juice

# BREAD STICKS AND MOCHI (RICE CAKE)

---

## MACHINE SET-UP:

1. Place the **Twin Gears** in position
2. Use the **Rice Cake Blank** (Total Blank) instead of Screens
3. Put the **Pulp Discharge Casing** into position
4. Tighten the **Latching Arm Knobs** snugly
5. Remove the **Outlet Adjusting Knob** from the **Pulp Discharge Outlet** and replace it with the **Rice Cake Guide**
6. Put a plate under the **Rice Cake Guide**

### Rye Bread Sticks

2	CUPS	RYE (SOAK OVERNIGHT)
½	CUP	SUNFLOWER SEEDS (SOAK OVERNIGHT)
2	TBSP	CARAWAY SEED
½	TSP	SEA SALT

#### Method:

1. Mix all ingredients together in a bowl
2. Feed into machine a little at a time
3. Collect bread sticks as they emerge from the **Pulp Discharge Outlet** formed into bread sticks by **Rice Cake Guide**
4. Before drying, these sticks can be shaped into pretzels, braided together, etc. for a variety of shapes
5. Dry in the dehydrator until crisp. Can be served with dips, soups, etc.

### Mochi (rice cake)

2	CUPS	STEAMED RICE (Medium Grain Rice recommended)
1	TSP	EXTRA VIRGIN OLIVE OIL

#### Method:

1. Prepare steamed rice
2. Add olive oil into the **Feeding Chute** while running the machine
3. Feed your steamed rice into **Feeding Chute**
4. Collect rice cake coming out of the **Rice Cake Guide** onto a plate

**Note:** Before processing, mix spices such as minced garlic or onion with the rice to flavor your rice cake. Slice the rice cake into diagonal slices. Dehydrate them and add to your soup.

# PASTA AND NOODLES

---

## MACHINE SET-UP:

1. Remove the **Pulp Discharge Casing** from the **Twin Gear Housing**
2. Remove the **Twin Gears** and insert the **Pasta Screw** onto the motor drive shaft (left side as you are looking into the body)
3. Place the **Pasta Guide** over the **Pasta Screw**, making sure the long side of the **Pasta Guide** faces to the left side
4. Select the pasta shape desired from the two shapes available on the **Pasta Screen** and fit it onto the **Twin Gear Housing**. (see diagram on page 16)
5. Tighten the **Latching Arm Knobs** snugly
6. Place a plate under **Pasta Screen**

### Pasta

1	PACKAGE	READY MIX PASTA DOUGH
1	TSP	EXTRA VIRGIN OLIVE OIL

### Method :

1. Prepare pasta dough according to the instructions on the package of the pasta dough mix
2. Put a few drops of olive oil into the **Feeding Chute** while running the machine
3. Feed your pasta dough into **Feeding Chute**
4. Collect your pasta onto a plate

### Variations :

If you use carrot juice when preparing the dough you will get red pasta. Use kale juice for green pasta and water for plain pasta.

*Note: A whistling sound will occur in the beginning; however, it will disappear later when your pasta comes out.*

# PATE AND CROQUETTES

---

## MACHINE SET-UP:

1. Place the **Twin Gears** in position
2. Use the **Homogenizing Blank**
3. Tighten the **Latching Arm Knobs** snugly
4. Tighten the **Outlet Adjusting Knob**
5. Place a bowl under the **Juice Outlet**

### Cashew-Curry Croquettes

2	CUPS	CASHEWS
1	CUP	SPROUTED WHEAT (Soak for 12 hours and let small tips emerge by sprouting)
3	TBSP	CURRY PASTE (Available from Gourmet Food Shops)
1	TSP	VEGE-SALT TO TASTE

#### Method:

1. Put the cashews and sprouted wheat berries into the **Feeding Chute**.
2. Add curry paste and vege-salt a little at a time while texturizing
3. Collect the texturized mixtures from the **Pulp Discharge Outlet**
4. Mix together by hand or with a wooden spoon
5. Form into croquettes and garnish with tomatoes, radish and cucumber

### Pecan Pleasers

2	CUPS	PECANS
1	CUP	SPROUTED WHEAT BERRIES (Soak 24 hours)
¼	CUP	SPANISH ONION
1	TSP	POULTRY SEASONING
½	TSP	VEGE-SALT

#### Method:

1. Put pecans, wheat berries, and onion into the **Feeding Chute**
2. Collect mixture in a bowl
3. Add the poultry seasoning and vege-salt
4. Mix thoroughly by hand or with a wooden spoon
5. Shape into small wafers and serve on cucumber slices with tomato or avocado on top

## MACHINE SET-UP:

### A. To Juice Carrots, Lemon, And Apple

1. Place the **Twin Gears** into position
2. Use the **Fine Screen**
3. Tighten the **Latching Arm Knobs** snugly

### B. To Grind Beets And Scallions

1. Place the **Twin Gears** into position
2. Use the **Homogenizing Blank**
3. Tighten the **Latching Arm Knobs** snugly

## Beet Borscht

JUICE- A	1	APPLE - Cut into 4 to 6 pieces
	8	CARROTS - Cut into 4 lengthwise pieces if the carrot is thick
	1/2	LEMON - Cut into 2 pieces
GRIND - B	2	BEETS
	2	GREEN SCALLIONS
	1 CUP	FINELY SHREDDED CABBAGE
		AVOCADO-YOGURT

### Method:

1. Juice carrots, lemon, and apple. Keep juice in a glass or the **Juice Pitcher**
2. Remove the **Fine Screen** and replace with the **Homogenizing Blank** to grind beets and scallions into a separate bowl
3. Add ground beets and scallions to the carrot, lemon and apple juice and mix
4. Fold in the finely grated cabbage
5. In a blender- blend avocado and yogurt together

### To serve:

Place borscht in a bowl. Top with a dollop of the avocado - yogurt combination

## MACHINE SET-UP:

1. Place the **Twin Gears** in position
2. Use the **Homogenizing Blank**
3. Put the **Plup Discharge Casing** into position
4. Tighten the **Latching Arm Knobs** snugly
5. Tighten the **Outlet Adjusting Knob**
6. Place a bowl under the **Juice Outlet**

### Cashew Poppy

1	CUP	SPROUTED WHEAT BERRIES - Soak for 12 hours and let small tips emerge by sprouting
1/4	CUP	POPPY SEEDS
1/4	CUP	SUNFLOWER SEEDS -SOAKED
1	CUP	CASHEWS
1/2	TSP	VANILLA
4	TBSP	HONEY

#### Method:

1. Mix wheat berries (soaked), sunflower seeds (soaked), cashew and poppy seeds together then grind through the machine
2. Collect the ground mixture from the **Juice Outlet** into a bowl
3. Add vanilla and honey and mix
4. Roll into balls and place on a plate

### Uncooked Banana- Blueberry Ice Cream Pie

1	CUP	SOAKED ALMONDS
1/2	CUP	SESAME SEEDS
1	CUP	CASHEWS
1/2	CUP	RAISINS
1/2	CUP	PITTED DATES
1/2	CUP	PECANS
1	TSP	VANILLA
2	TBSP	HONEY
7		FROZEN BANANAS (WITHOUT SKINS)
1 1/2	CUPS	FROZEN BLUE BERRIES
1		KIWI (SLICED)
2		LARGE STRAWBERRIES (SLICED)

#### Method:

1. Grind almonds, cashews, sesame, pecans, dates and raisins together
2. Mix in the vanilla and honey; knead to form dough: then press into a 9" pie dish to form a crust. Let crust sit for 3 to 4 hours or place in a food dehydrator for about 3/4 hour.
3. Grind frozen bananas and frozen blueberries together to make ice cream.
4. Put ice cream into the crust, top with slices of strawberries and kiwi. Slice and serve.

**PRODUCT STANDARD**

ITEM	VEGETABLE JUICER
MODEL	GREEN STAR™ JUICER
VOLTAGE	AC 120V
FREQUENCY	60Hz
ELECTRIC POWER	190W
SIZE	476mm × 165mm × 306mm
WEIGHT	8.7kg

## **V0801GS**

\* Updated in August 2001.

This version supersedes all former manuals issued before this date.